

- EXTRUDED ALUMINUM CONSTRUCTION
- MINIMUM SIZE = 12 INCHES
- MAXIMUM SIZE = 72 INCHES ONE PIECE CONSTRUCTION
- MULTIPLE SECTIONS KEYED FOR PROPER ALIGNMENT
- DIFFUSERS AVAILABLE WITH ONE TO TEN SLOTS, WITH OR WITHOUT PATTERN CONTROLLER OR DAMPER
- FINISH: WHITE (W) ENAMEL OR SATIN ANODIZED (SA)

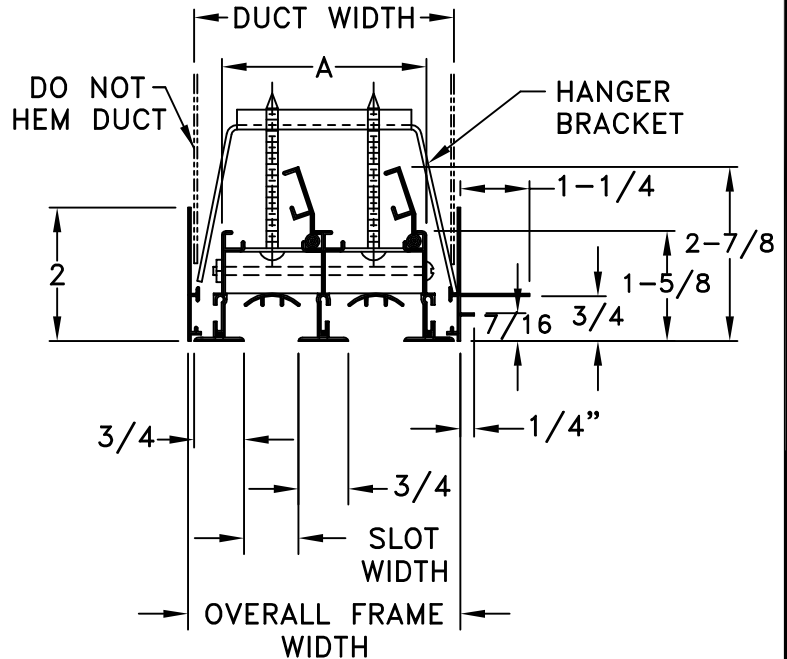

- FOR CONCEALED MOUNTING OF FLUSH FRAME ALONG WALLS/FIXTURES
- CONTRACTOR TO FRAME OPENING TO INSURE STRAIGHT LINE INSTALLATION (TYPICAL ALL INSTALLATIONS)

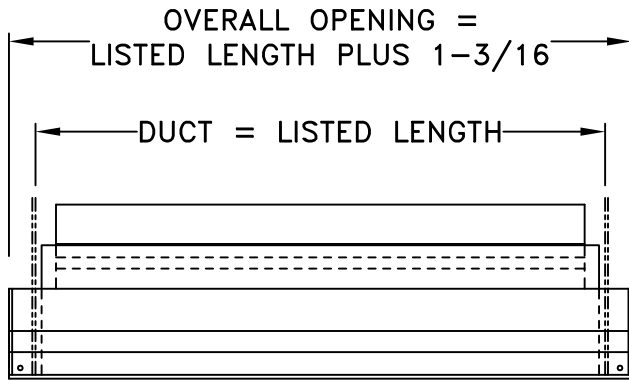

MARGIN ONLY



MARGIN AND PATTERN CONTROLLER

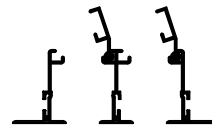

MARGIN AND DAMPER

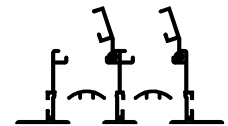

MARGIN, DAMPER AND PATTERN CONTROLLER

SLOT WIDTH	TYPE	A	DUCT WIDTH	OVERALL FRAME WIDTH
1/2	50	1-1/4 X NO. OF SLOTS	A + 13/16	A + 15/16
3/4	75	1-1/2 X NO. OF SLOTS	A + 13/16	A + 15/16
1	10	1-3/4 X NO. OF SLOTS	A + 13/16	A + 15/16

JOB NAME: _____
 LOCATION: _____
 ARCHITECT: _____
 ENGINEER: _____
 CONTRACTOR: _____

SUBMITTED BY: _____

DATE: 3/12/08

SD-9613

S SERIES

Slot Diffuser
 Margin B3-Surface Mount with
 Plaster Frame