



Hart & Cooley[®]
install confidence

Light Commercial Grilles, Registers & Diffusers

Edition 5

See
Inside
Front
Cover For
What's New...

LIGHT COMMERCIAL

| | | Product Information | Engineering Data |
|-----------------------------------|--|------------------------|---------------------|
| CEILING DIFFUSERS—STEEL | | | |
| 20 | Round Adjustable | .28 | .86 |
| 18 | Duct Ring | .28 | |
| 19 | Round OB Damper | .28 | |
| 24 | Steel Square (Ceiling) Diffuser | .29 | .86 |
| 21 | Steel Square Mounting Frame | .29 | |
| 22 | Steel Butterfly Damper with Mounting Frame | .29 | |
| 23 | Steel Opposed Blade Damper | .29 | |
| SRE | Directional, Extended Frame | .30 | .87-92 |
| SRS | Directional, Step Frame | .30 | .87-92 |
| SR6 | Control Grid | .31 | |
| SR7 | OB Damper | .31 | |
| SR/AR | Air Patterns and Listed Sizes | .34 | |
| CEILING DIFFUSERS—ALUMINUM | | | |
| ARE | Directional, Extended Frame | .32 | .87-92 |
| ARF | Directional, Flush Frame | .32 | .87-92 |
| ARS | Directional, Step Frame | .33 | .87-92 |
| AR6 | Control Grid | .33 | |
| AR7 | OB Damper | .33 | |
| SR/AR | Air Patterns and Listed Sizes | .34 | |
| ASRE | Supply/Return, Extended Frame | .35 | .93-94 |
| ASRS | Supply/Return, Step Frame | .35 | .93-94 |
| MCD/MCDD | Modular Diffuser (OB Option), Extended Frame | .36-37 | .95-96 |
| MCDS/MCSD | Modular Diffuser (OB Option), Step Frame | .36-37 | .95-96 |
| | T-Bar Panel | .37 | .95-96 |



20 Round Diffuser

- Steel construction
- For ceiling or exposed duct installation
- Five-step positioning of air pattern adjustment
- 360-degree pattern, horizontal to vertical pattern change
- Removable center core
- Diffusers are equipped with margins designed to minimize smudging
- Diffuser outer shell fastens directly to duct or to optional #18 duct ring; margins fit tight to ceiling for optimum ceiling appearance
- Optional #19 damper; duct-mount only
- Bright White finish

| 20 Available Sizes (in.) | | | | | |
|--------------------------|----------------------------------|--------------------------------|--------------------------------|---------------------------------|---------------------------------|
| Listed Size | Ceiling Opening Diameter | Overall Diameter | C | D | E |
| 6 | 11 | 12 ⁷ / ₈ | ³ / ₈ | 1 ³ / ₈ | 1 ³ / ₄ |
| 8 | 14 ³ / ₄ | 17 | ¹ / ₂ | 1 ¹³ / ₁₆ | 2 ⁵ / ₁₆ |
| 10 | 18 ³ / ₈ | 21 | ⁵ / ₈ | 2 ³ / ₁₆ | 2 ¹⁵ / ₁₆ |
| 12 | 21 ¹⁵ / ₁₆ | 25 ¹ / ₄ | ⁹ / ₈ | 2 ⁹ / ₁₆ | 3 ¹ / ₂ |
| 14 | 25 ¹ / ₂ | 28 ¹ / ₂ | ¹¹ / ₁₆ | 2 ⁷ / ₈ | 4 ¹ / ₄ |
| 16 | 29 ¹ / ₈ | 33 ³ / ₈ | ⁷ / ₈ | 3 ³ / ₈ | 4 ³ / ₄ |
| 18 | 32 ³ / ₄ | 37 ¹ / ₂ | 1 ¹ / ₁₆ | 4 ³ / ₁₆ | 5 ³ / ₈ |

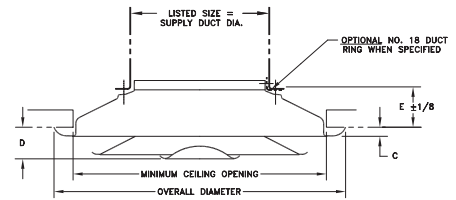

18 Duct Ring

- Steel construction
- Attaches to diffuser via screws into face by removing core
- Bright White finish
- Use with #20 diffuser

| 18 Available Sizes (in.) | | | | | | |
|--------------------------|---|----|----|----|----|----|
| 6 | 8 | 10 | 12 | 14 | 16 | 18 |

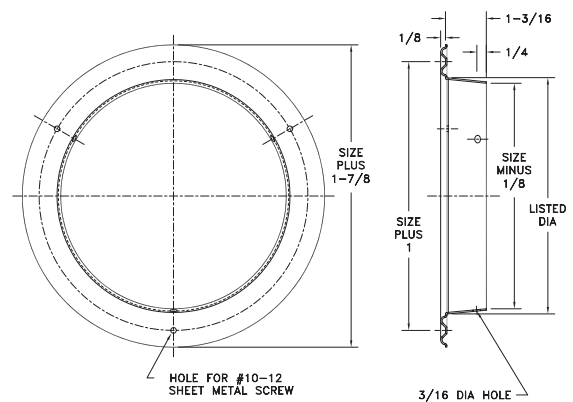

19 Damper

- Steel construction
- Opposed-blade damper
- Bright White finish
- Duct-mount only

| 19 Damper Listed Sizes (in.) | | | | | | | | |
|------------------------------|---------------------------------|---------------------------------|---------------------------------|----------------------------------|----------------------------------|----------------------------------|----------------------------------|----------------------------------|
| Damper | 6 | 8 | 10 | 12 | 14 | 15 | 16 | 18 |
| S | 5 ¹⁵ / ₁₆ | 7 ¹⁵ / ₁₆ | 9 ¹⁵ / ₁₆ | 11 ¹⁵ / ₁₆ | 13 ¹⁵ / ₁₆ | 14 ¹⁵ / ₁₆ | 15 ¹⁵ / ₁₆ | 17 ¹⁵ / ₁₆ |
| P | 3 | 3 ¹ / ₂ | 4 ⁹ / ₁₆ | 4 ⁹ / ₁₆ | 4 ⁹ / ₁₆ | 4 ⁹ / ₁₆ | 4 ⁹ / ₁₆ | 4 ⁹ / ₁₆ |

Note: 3/16" Hex Damper handle (by others) will lock into position if inserted too far into damper

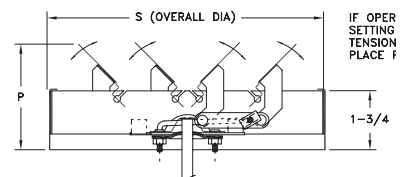

CROSS SECTION WITH VALVES PARTLY OPEN SHOWING OPPOSED-BLADE OPERATION



24 Square Ceiling Diffuser

- All-steel construction
- Step-down face deflects air stream 360 degrees
- Bright White finish

Only available in sizes shown.

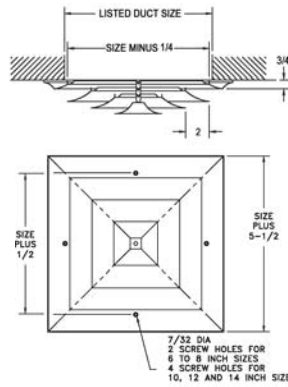

| 24 Ceiling Diffuser (in.) | | |
|---------------------------|----------------------|--------------|
| Size | Free Area Sq. Inches | No. of Cones |
| 6 | 41 | 3 |
| 8 | 65 | 3 |
| 10 | 84 | 3 |
| 12 | 123 | 4 |
| 14 | 152 | 4 |
| 16 | 199 | 5 |
| 18 | 236 | 5 |
| 20 | 293 | 6 |
| 22 | 338 | 6 |
| 24 | 404 | 7 |

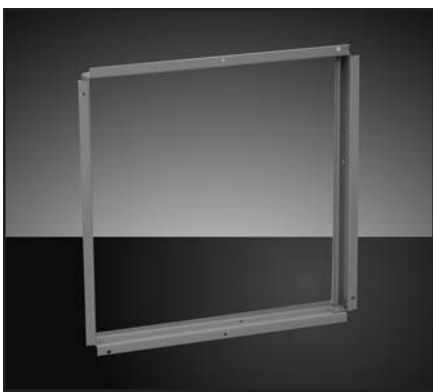

21 Installation Frame

- All-steel construction
- Golden Sand enamel finish
- Used but not furnished with #24 ceiling diffusers.

Not required when using 22 Butterfly Damper or 23 Opposed Blade Damper.

Cannot be used with SD and SDD.

| 21 Available Sizes (in.) | |
|--------------------------------------|--|
| 6, 8, 10, 12, 14, 16, 18, 20, 22, 24 | |

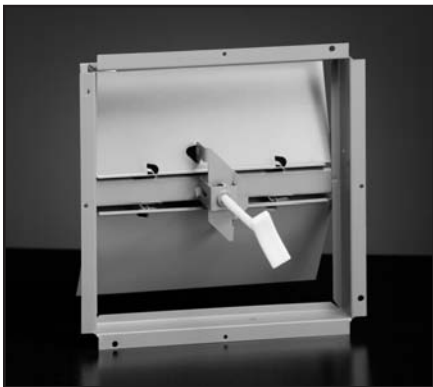
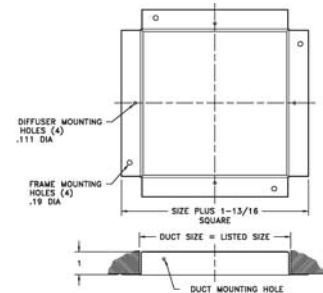

22 Butterfly Damper

- All-steel construction
- Used with #24 Ceiling Diffuser
- Knob control for quick adjustment (removable)
- Installation flange included
- Golden Sand enamel finish

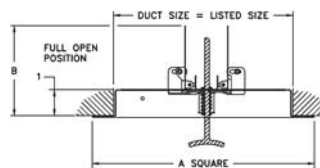

| 22 Available Sizes (in.) | | |
|--------------------------|---------------------------------|---------------------------------|
| Size | A | B |
| 6 | 6 ³ / ₁₆ | 3 ¹¹ / ₁₆ |
| 8 | 8 ³ / ₁₆ | 4 ¹¹ / ₁₆ |
| 10 | 10 ³ / ₁₆ | 5 ¹¹ / ₁₆ |
| 12 | 12 ³ / ₁₆ | 6 ¹¹ / ₁₆ |
| 14 | 14 ³ / ₁₆ | 7 ¹¹ / ₁₆ |

Only available in sizes shown.

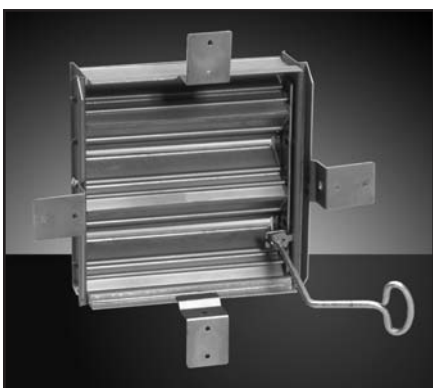

23 Opposed-Blade Damper

- All-steel construction
- Used with #24 Ceiling Diffuser
- Controls air volume over entire diffuser
- Key operated
- Mill finish

| 23 Available Sizes (in.) | |
|--------------------------------------|--|
| 6, 8, 10, 12, 14, 16, 18, 20, 22, 24 | |

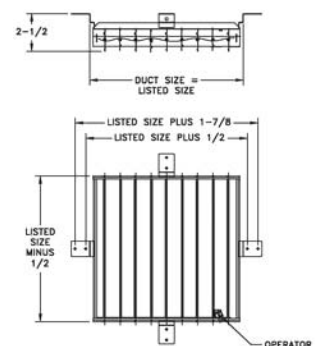

Ceiling Diffusers - Steel



SRE Diffuser

- Steel construction
- Removable core
- Flat (extended) margin style
- Optional factory-mounted opposed-blade damper available as SRED
- Bright White enamel finish

| SRE Available Sizes (in.) | | | | | | | |
|---------------------------|-------|---|----|----|----|----|----|
| HT | WIDTH | | | | | | |
| | 6 | 9 | 12 | 15 | 18 | 21 | 24 |
| 6 | X | X | X | X | X | X | X |
| 9 | | X | X | X | X | X | X |
| 12 | | | X | X | X | X | X |
| 15 | | | | X | X | X | X |
| 18 | | | | | X | X | X |
| 21 | | | | | | X | X |
| 24 | | | | | | | X |

See page 34 for available air patterns.

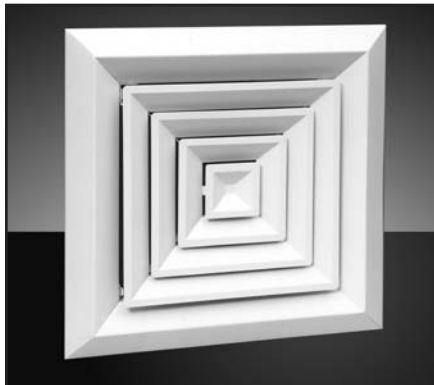
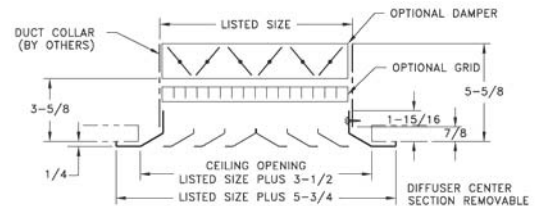

SRS Diffuser

- Steel construction
- Removable core
- Beveled (step-down) margin style
- Optional factory-mounted opposed-blade damper available as SRSD
- Bright White enamel finish

| SRS Available Sizes (in.) | | | | | | | |
|---------------------------|-------|---|----|----|----|----|----|
| HT | WIDTH | | | | | | |
| | 6 | 9 | 12 | 15 | 18 | 21 | 24 |
| 6 | X | X | X | X | X | X | X |
| 9 | | X | X | X | X | X | X |
| 12 | | | X | X | X | X | X |
| 15 | | | | X | X | X | X |
| 18 | | | | | X | X | X |
| 21 | | | | | | X | X |
| 24 | | | | | | | X |

See page 34 for available air patterns.

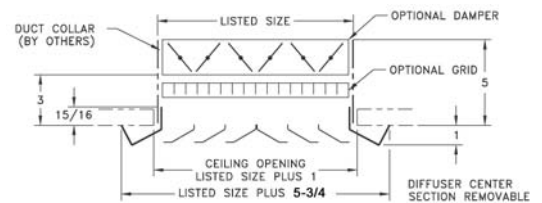

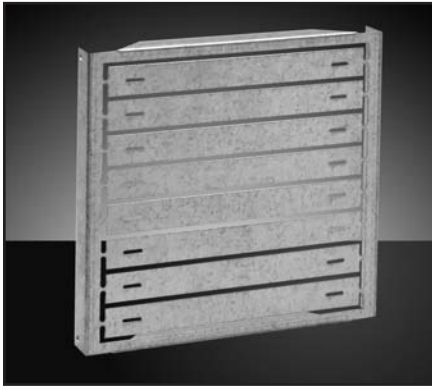

SR6 Control Grid

- Steel construction
- Field-mounts on diffuser
- Used to control airflow at the diffuser
- Mill finish

| SR6 Available Sizes (in.) | | | | | | | |
|---------------------------|-------|---|----|----|----|----|----|
| HT | WIDTH | | | | | | |
| | 6 | 9 | 12 | 15 | 18 | 21 | 24 |
| 6 | X | X | X | X | X | X | X |
| 9 | | X | X | X | X | X | X |
| 12 | | | X | X | X | X | X |
| 15 | | | | X | X | X | X |
| 18 | | | | | X | X | X |
| 21 | | | | | | X | X |
| 24 | | | | | | | X |

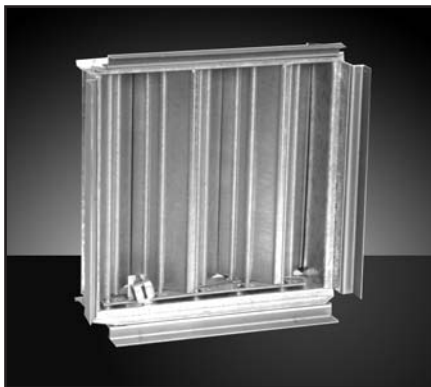
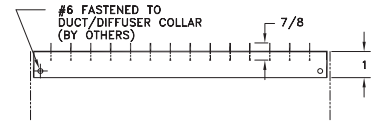
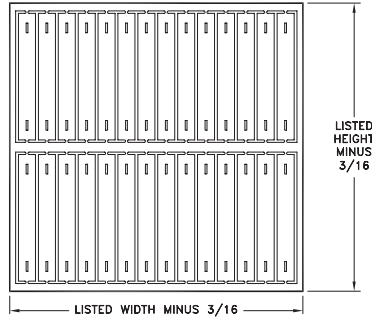

SR7 Volume Damper

- Steel construction
- Used to control airflow at the diffuser
- Mill finish
- Duct-mount only

| SR7 Available Sizes (in.) | | | | | | | |
|---------------------------|-------|---|----|----|----|----|----|
| HT | WIDTH | | | | | | |
| | 6 | 9 | 12 | 15 | 18 | 21 | 24 |
| 6 | X | X | X | X | X | X | X |
| 9 | | X | X | X | X | X | X |
| 12 | | | X | X | X | X | X |
| 15 | | | | X | X | X | X |
| 18 | | | | | X | X | X |
| 21 | | | | | | X | X |
| 24 | | | | | | | X |

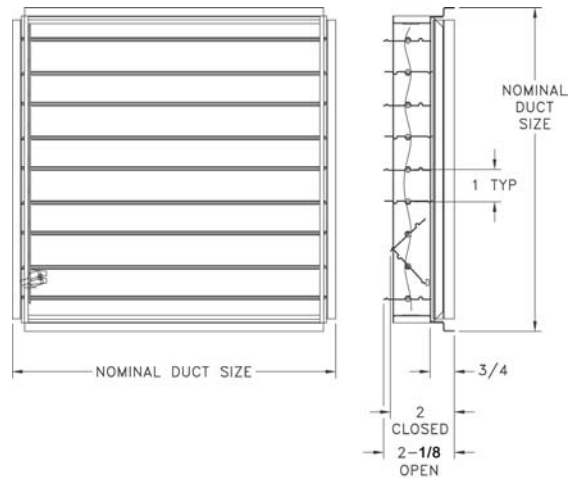

Ceiling Diffusers - Aluminum



ARE Diffuser

- Extruded aluminum construction
- Removable core
- Flat (extended) margin style
- Optional factory-mounted aluminum opposed-blade damper available as ARE D
- Bright White or Satin Anodized finish

| ARE Available Sizes (in.) | | | | | | | | | | | |
|---------------------------|-------|---|----|----|----|----|----|----|----|----|----|
| HT | WIDTH | | | | | | | | | | |
| | 6 | 9 | 12 | 15 | 18 | 21 | 24 | 27 | 30 | 33 | 36 |
| 6 | X | X | X | X | X | X | X | X | X | X | X |
| 9 | | X | X | X | X | X | X | X | X | X | X |
| 12 | | | X | X | X | X | X | X | X | X | X |
| 15 | | | | X | X | X | X | X | X | X | X |
| 18 | | | | | X | X | X | X | X | X | X |
| 21 | | | | | | X | X | X | X | X | X |
| 24 | | | | | | | X | X | X | X | X |
| 27 | | | | | | | | X | X | X | X |
| 30 | | | | | | | | | X | X | X |
| 33 | | | | | | | | | | X | X |
| 36 | | | | | | | | | | | X |

Note: Number of cones varies by size of diffuser

See page 34 for available air patterns.

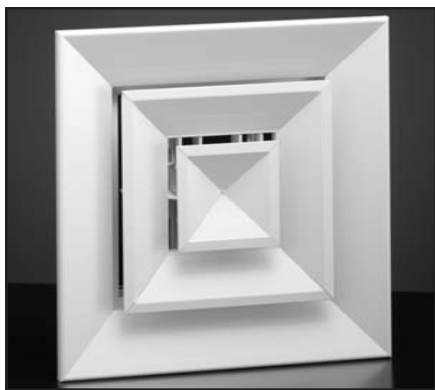
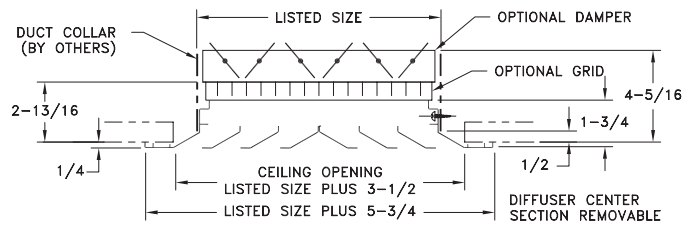

ARF Diffuser

- Extruded aluminum construction
- Removable core
- Flush margin style
- Optional factory-mounted aluminum opposed-blade damper available as ARFD
- Bright White or Satin Anodized finish

| ARF Available Sizes (in.) | | | | | | | | | | | |
|---------------------------|-------|---|----|----|----|----|----|----|----|----|----|
| HT | WIDTH | | | | | | | | | | |
| | 6 | 9 | 12 | 15 | 18 | 21 | 24 | 27 | 30 | 33 | 36 |
| 6 | X | X | X | X | X | X | X | X | X | X | X |
| 9 | | X | X | X | X | X | X | X | X | X | X |
| 12 | | | X | X | X | X | X | X | X | X | X |
| 15 | | | | X | X | X | X | X | X | X | X |
| 18 | | | | | X | X | X | X | X | X | X |
| 21 | | | | | | X | X | X | X | X | X |
| 24 | | | | | | | X | X | X | X | X |
| 27 | | | | | | | | X | X | X | X |
| 30 | | | | | | | | | X | X | X |
| 33 | | | | | | | | | | X | X |
| 36 | | | | | | | | | | | X |

Note: Number of cones varies by size of diffuser

See page 34 for available air patterns.

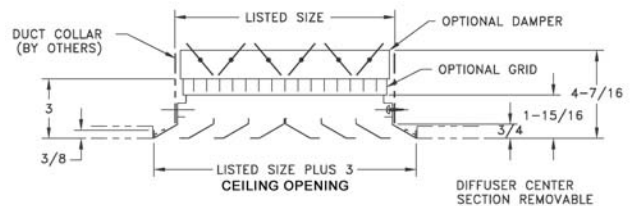

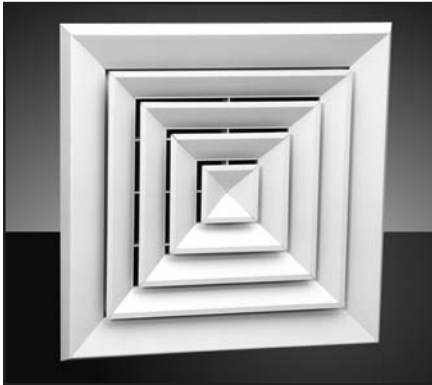

ARS Diffuser

- Extruded aluminum construction
- Removable core
- Beveled (step-down) margin style
- Optional factory-mounted aluminum opposed-blade damper available as ARSD
- Bright White or Satin Anodized finish

| ARS Available Sizes (in.) | | | | | | | | | | | |
|---------------------------|-------|---|----|----|----|----|----|----|----|----|----|
| HT | WIDTH | | | | | | | | | | |
| | 6 | 9 | 12 | 15 | 18 | 21 | 24 | 27 | 30 | 33 | 36 |
| 6 | X | X | X | X | X | X | X | X | X | X | X |
| 9 | | X | X | X | X | X | X | X | X | X | X |
| 12 | | | X | X | X | X | X | X | X | X | X |
| 15 | | | | X | X | X | X | X | X | X | X |
| 18 | | | | | X | X | X | X | X | X | X |
| 21 | | | | | | X | X | X | X | X | X |
| 24 | | | | | | | X | X | X | X | X |
| 27 | | | | | | | | X | X | X | X |
| 30 | | | | | | | | | X | X | X |
| 33 | | | | | | | | | | X | X |
| 36 | | | | | | | | | | | X |

Note: Number of cones varies by size of diffuser

See page 34 for available air patterns.

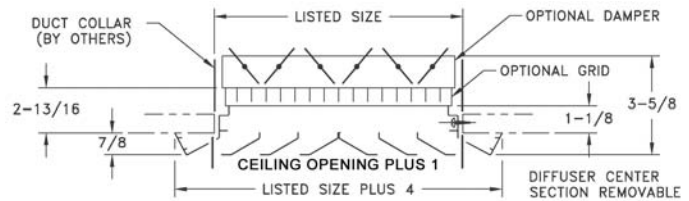

AR6 Control Grid

- Extruded aluminum construction
- Mounts on diffuser hanger bracket
- Provides uniform airflow in diffuser collar
- Mill finish

| AR6 Available Sizes (in.) |
|---|
| Minimum: 6" x 6" |
| Maximum: 36" x 36" (in multiple sections) |

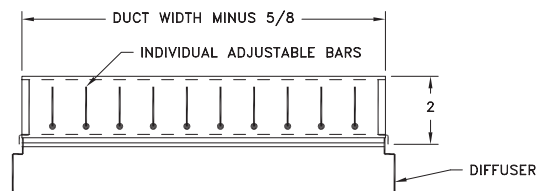







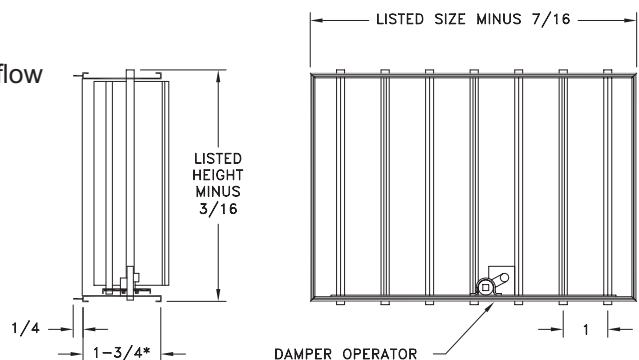



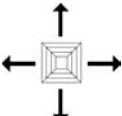
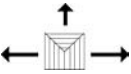
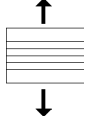
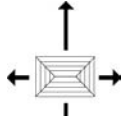
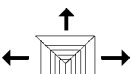

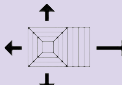
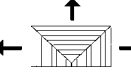
AR7 Damper

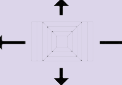
- Extruded aluminum construction
- Mounts on diffuser hanger bracket
- Used to control airflow at the diffuser
- Mill finish

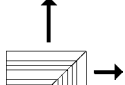
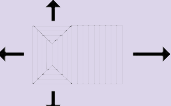
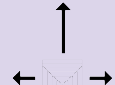
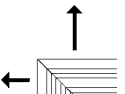
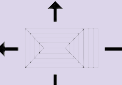
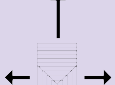
| AR7 Available Sizes (in.) |
|---|
| Minimum: 6" x 6" |
| Maximum: 36" x 36" (in multiple sections) |

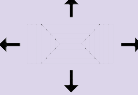

Neck View Type SR & AR Air Patterns

| Style | Listed Sizes | Style | Listed Sizes | Style | Listed Sizes |
|--|--|--|---|--|---|
|  STYLE 4 | 6x6 24x24 9x9 27x27 12x12 30x30 15x15 33x33 18x18 36x36 21x21 24 x 24 Max. in Steel |  STYLE 3 | 6x6 24x24 9x9 27x27 12x12 30x30 15x15 33x33 18x18 36x36 21x21 24 x 24 Max. in Steel |  STYLE 2L | 9x6 to 36x6 24x21 to 36x21 12x9 to 36x9 27x24 to 36x24 15x12 to 36x12 30x27 to 36x27 18x15 to 36x15 33x30 to 36x30 21x18 to 36x18 36x33 24 x 21 Max. in Steel |
|  STYLE 4 | 9x6 to 45x6 24x21 to 45x21 12x9 to 45x9 27x24 to 45x24 15x12 to 45x12 30x27 to 45x27 18x15 to 45x15 33x30 to 45x30 21x18 to 45x18 36x33 to 45x33 24 x 21 Max. in Steel |  STYLE 3S | 9x6 24x21 to 36x21 12x9 27x24 to 42x24 15x9 30x27 to 42x27 15x12 to 21x12 33x30 to 42x30 18x15 to 27x15 36x33 21x18 to 33x18 24 x 21 Max. in Steel |  STYLE 2S | 9x6 to 36x6 24x21 to 36x21 12x9 to 36x9 27x24 to 36x24 15x12 to 36x12 30x27 to 36x27 18x15 to 36x15 33x30 to 36x30 21x18 to 36x18 36x33 24 x 21 Max. in Steel |
|  STYLE 41 | 9x6 to 36x6 24x21 to 36x21 12x9 to 36x9 27x24 to 36x24 15x12 to 36x12 30x27 to 36x27 18x15 to 36x15 33x30 to 36x30 21x18 to 36x18 36x33 |  STYLE 3S | 12x6 18x9 24x12 30x15 36x18 |  STYLE 2C | 6x6 24x24 9x9 27x27 12x12 30x30 15x15 33x33 18x18 36x36 21x21 |
|  STYLE 42 | 9x6 to 36x6 24x21 to 36x21 12x9 to 36x9 27x24 to 36x24 15x12 to 36x12 30x27 to 36x27 18x15 to 36x15 33x30 to 36x30 21x18 to 36x18 36x33 |  STYLE 3S | 15x6 to 36x6 21x9 to 36x9 27x12 to 36x12 33x15 36x15 |  STYLE 2CR | 9x6 to 36x6 24x21 to 36x21 12x9 to 36x9 27x24 to 36x24 15x12 to 36x12 30x27 to 36x27 18x15 to 36x15 33x30 to 36x30 21x18 to 36x18 36x33 24 x 21 Max. in Steel |
|  STYLE 41L | 9x9 to 36x9 24x24 to 36x24 12x12 to 36x12 27x27 to 36x27 15x15 to 36x15 30x30 to 36x30 18x18 to 36x18 33x33 to 36x33 21x21 to 36x21 36x36 |  STYLE 31S | 6x6 to 9x6 24x24 to 36x24 9x9 to 15x9 27x27 to 36x27 12x12 to 21x12 30x30 to 36x30 15x15 to 27x15 33x33 to 36x33 18x18 to 33x18 36x36 21x21 to 36x21 |  STYLE 2CL | 9x6 to 36x6 24x21 to 36x21 12x9 to 36x9 27x24 to 36x24 15x12 to 36x12 30x27 to 36x27 18x15 to 36x15 33x30 to 36x30 21x18 to 36x18 36x33 24 x 21 Max. in Steel |
|  STYLE 41S | 12x6 to 36x6 27x21 to 36x21 15x9 to 36x9 30x24 to 36x24 18x12 to 36x12 33x27 to 36x27 21x15 to 36x15 36x30 24x18 to 36x18 |  STYLE 31L | 9x6 to 36x6 24x21 to 36x21 12x9 to 36x9 27x24 to 36x24 15x12 to 36x12 30x27 to 36x27 18x15 to 36x15 33x30 to 36x30 21x18 to 36x18 36x33 |  STYLE 1 | 6x6 27x27 9x9 30x30 12x12 33x33 15x15 36x36 18x18 39x39 21x21 42x42 24x24 24 x 24 Max. in Steel |
|  STYLE 42S | 12x6 to 36x6 27x21 to 36x21 15x9 to 36x9 30x24 to 36x24 18x12 to 36x12 33x27 to 36x27 21x15 to 36x15 36x30 24x18 to 36x18 |  STYLE 3L | 9x6 to 36x6 24x21 to 36x21 12x9 to 36x9 27x24 to 36x24 15x12 to 36x12 30x27 to 36x27 18x15 to 36x15 33x30 to 36x30 21x18 to 36x18 36x33 24 x 21 Max. in Steel |  STYLE 1L | 9x6 to 36x6 24x21 to 36x21 12x9 to 36x9 27x24 to 36x24 15x12 to 36x12 30x27 to 36x27 18x15 to 36x15 33x30 to 36x30 21x18 to 36x18 36x33 24 x 21 Max. in Steel |
| | |  STYLE 2 | 6x6 24x24 9x9 27x27 12x12 30x30 15x15 33x33 18x18 36x36 21x21 24 x 24 Max. in Steel |  STYLE 1S | 9x6 to 36x6 24x21 to 36x21 12x9 to 36x9 27x24 to 36x24 15x12 to 36x12 30x27 to 36x27 18x15 to 36x15 33x30 to 36x30 21x18 to 36x18 36x33 24 x 21 Max. in Steel |

 Aluminum Only

SR Sizes:
6x6 to 24x24 in 3" Increments (see page 64)

AR Sizes:
6x6 to 36x36 in 3" Increments (see page 66)

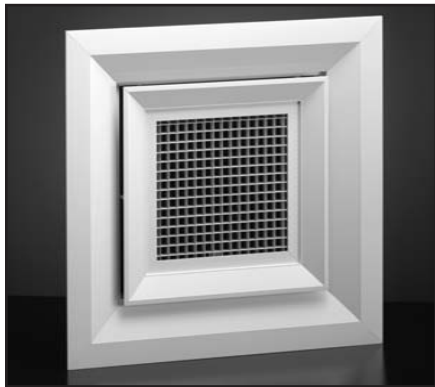

ASRE Diffuser

- Extruded aluminum construction
- Flat (extended) margins overlap opening
- For use with roof-mounted installations
- Removable core
- Return damper available - AR7
- Supply damper available - AS7
- Bright White or Satin Anodized finish

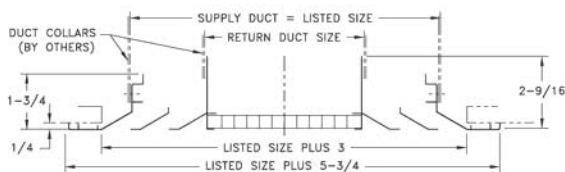

| ASRE Available Sizes (in.) | | | |
|----------------------------|-------------|-------------|-------------|
| Supply Size | Return Neck | Supply Size | Return Neck |
| 9 x 9 | 6 x 6 | 27 x 18 | 21 x 12 |
| 12 x 12 | 9 x 9 | 27 x 15 | 21 x 9 |
| 12 x 9 | 9 x 6 | 27 x 12 | 21 x 6 |
| 15 x 15 | 9 x 9 | 30 x 30 | 21 x 21 |
| 15 x 12 | 12 x 9 | 30 x 27 | 21 x 18 |
| 15 x 9 | 12 x 6 | 30 x 24 | 21 x 15 |
| 15 x 6 | 12 x 3 | 30 x 21 | 21 x 12 |
| 18 x 18 | 12 x 12 | 30 x 18 | 24 x 12 |
| 18 x 15 | 12 x 9 | 30 x 15 | 24 x 9 |
| 18 x 12 | 12 x 6 | 33 x 33 | 21 x 21 |
| 18 x 9 | 15 x 6 | 33 x 30 | 24 x 21 |
| 21 x 21 | 15 x 15 | 33 x 27 | 24 x 18 |
| 21 x 18 | 15 x 12 | 33 x 24 | 24 x 15 |
| 21 x 15 | 15 x 9 | 33 x 21 | 24 x 12 |
| 21 x 12 | 15 x 6 | 33 x 18 | 27 x 12 |
| 21 x 9 | 18 x 6 | 33 x 15 | 27 x 9 |
| 24 x 24 | 18 x 18 | 36 x 36 | 24 x 24 |
| 24 x 21 | 18 x 15 | 36 x 33 | 27 x 24 |
| 24 x 18 | 18 x 12 | 36 x 30 | 27 x 21 |
| 24 x 15 | 18 x 9 | 36 x 27 | 27 x 18 |
| 24 x 12 | 18 x 6 | 36 x 24 | 27 x 15 |
| 24 x 9 | 21 x 6 | 36 x 21 | 27 x 12 |
| 27 x 27 | 18 x 18 | 36 x 18 | 30 x 12 |
| 27 x 24 | 18 x 15 | 42 x 18 | 27 x 12 |
| 27 x 21 | 21 x 15 | | |



ASRS Diffuser

- Extruded aluminum construction
- Step-down (beveled) margins overlap opening and lowers the diffuser from the ceiling
- For use with roof-mounted installations
- Removable core
- Bright White or Satin Anodized finish
- Return damper available - AR7
- Supply damper available - AS7

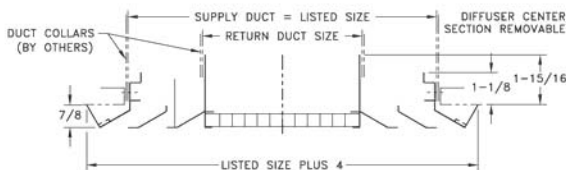

| ASRS Available Sizes (in.) | | | |
|----------------------------|-------------|-------------|-------------|
| Supply Size | Return Neck | Supply Size | Return Neck |
| 9 x 9 | 6 x 6 | 27 x 18 | 21 x 12 |
| 12 x 12 | 9 x 9 | 27 x 15 | 21 x 9 |
| 12 x 9 | 9 x 6 | 27 x 12 | 21 x 6 |
| 15 x 15 | 9 x 9 | 30 x 30 | 21 x 21 |
| 15 x 12 | 12 x 9 | 30 x 27 | 21 x 18 |
| 15 x 9 | 12 x 6 | 30 x 24 | 21 x 15 |
| 15 x 6 | 12 x 3 | 30 x 21 | 21 x 12 |
| 18 x 18 | 12 x 12 | 30 x 18 | 24 x 12 |
| 18 x 15 | 12 x 9 | 30 x 15 | 24 x 9 |
| 18 x 12 | 12 x 6 | 33 x 33 | 21 x 21 |
| 18 x 9 | 15 x 6 | 33 x 30 | 24 x 21 |
| 21 x 21 | 15 x 15 | 33 x 27 | 24 x 18 |
| 21 x 18 | 15 x 12 | 33 x 24 | 24 x 15 |
| 21 x 15 | 15 x 9 | 33 x 21 | 24 x 12 |
| 21 x 12 | 15 x 6 | 33 x 18 | 27 x 12 |
| 21 x 9 | 18 x 6 | 33 x 15 | 27 x 9 |
| 24 x 24 | 18 x 18 | 36 x 36 | 24 x 24 |
| 24 x 21 | 18 x 15 | 36 x 33 | 27 x 24 |
| 24 x 18 | 18 x 12 | 36 x 30 | 27 x 21 |
| 24 x 15 | 18 x 9 | 36 x 27 | 27 x 18 |
| 24 x 12 | 18 x 6 | 36 x 24 | 27 x 15 |
| 24 x 9 | 21 x 6 | 36 x 21 | 27 x 12 |
| 27 x 27 | 18 x 18 | 36 x 18 | 30 x 12 |
| 27 x 24 | 18 x 15 | 42 x 18 | 27 x 12 |
| 27 x 21 | 21 x 15 | | |

Ceiling Diffusers - Aluminum



MCD Adjustable Modular Diffuser

- Extruded aluminum construction
- Four modular cores provide variable pattern adjustments of four-way, three-way, two-way, or one-way horizontal air patterns
- Flat (extended) margin
- Fixed fins
- Bright White finish

| MCD Available Sizes (in.) |
|--|
| 6" x 6", 8" x 8", 10" x 10", 12" x 12", 14" x 14", 16" x 16", 18" x 18", 20" x 20", 22" x 22" |

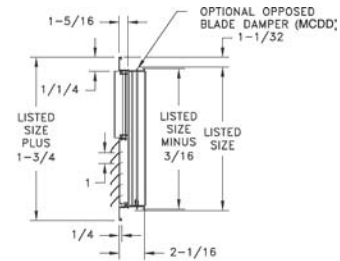

MCDD Adjustable Modular Diffuser

- Extruded aluminum construction
- Opposed-blade damper
- Four modular cores provide variable pattern adjustments of four-way, three-way, two-way, or one-way horizontal air patterns
- Removable modules provide easy access to damper
- Flat (extended) margin
- Fixed fins
- Bright White finish

| MCDD Available Sizes (in.) |
|--|
| 6" x 6", 8" x 8", 10" x 10", 12" x 12", 14" x 14", 16" x 16", 18" x 18", 20" x 20", 22" x 22" |

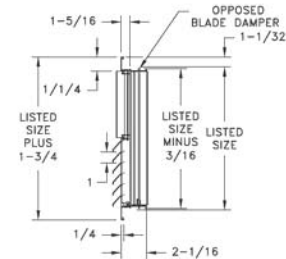

MCDS Adjustable Modular Diffuser

- Extruded aluminum construction
- Step-down (beveled) margin
- Four modular cores provide variable pattern adjustments of four-way, three-way, two-way, or one-way horizontal air patterns
- Fixed fins
- Bright White finish

| MCDS Available Sizes (in.) |
|--|
| 6" x 6", 8" x 8", 10" x 10", 12" x 12", 14" x 14", 16" x 16", 18" x 18", 20" x 20", 22" x 22" |

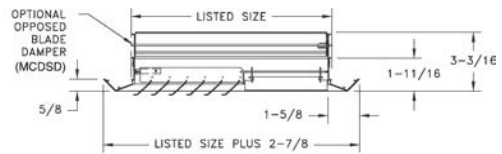

For T-Bar application, see page 69.



MCDSD Adjustable Modular Diffuser

- Extruded aluminum construction
- Opposed-blade damper
- Step-down (beveled) margin
- Four modular cores provide variable pattern adjustments of four-way, three-way, two-way, or one-way horizontal air patterns
- Removable modules provide easy access to damper
- Fixed fins
- Bright White finish

| MCDSD Available Sizes (in.) |
|--|
| 6" x 6", 8" x 8", 10" x 10", 12" x 12", 14" x 14", 16" x 16", 18" x 18", 20" x 20", 22" x 22" |

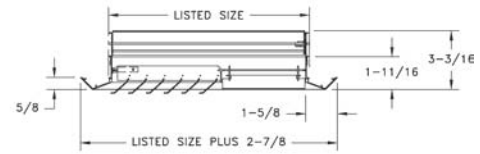

For T-Bar application, see page 69.

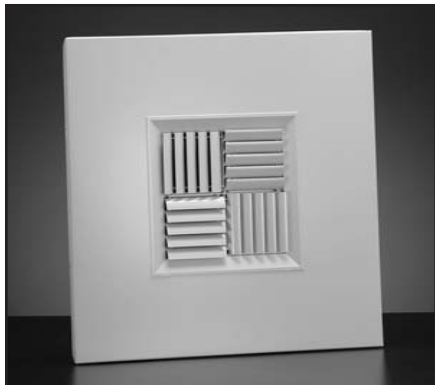

Modular T-Bar Panel

- Steel construction (aluminum optional)
- Adapts MCD and MCDD for T-Bar installation
- Bright White finish
- See page 101

Note: Aluminum panel for factory-mounted step-down margin. Available as Models MCDST and MCDSDT.

| Modular T-Bar Panel Available Sizes |
|-------------------------------------|
| Opening 6" - 20" |
| Overall 23-3/4" x 23-3/4" |

