

**heatfab<sup>®</sup>**

# SGV/DGV

## Special Gas Vent

Single Wall and Double Wall Vent System

**NEW**  
**4X3**  
STAINLESS  
STEEL



GAS



**SGV**  
SPECIAL  
GAS VENT

**3" & 4"**  
**Single Wall Stainless Steel**  
**Special Gas Vent**

**DGV**  
SPECIAL  
GAS VENT

**3"/5" & 4"/7"**  
**Double Wall Stainless Steel**  
**Special Gas Vent**



Tested and Listed to  
UL 1738 & ULC-S636  
By Underwriters Laboratories, Inc

## Specifications

Model SGV is a single wall Gas Vent System that may be used to vent safety certified Category I, II, III and IV and gas fired appliances with a flue gas temperature of not more than 550° F (288° C). SGV system is for use with appliances that produce positive vent pressures of 9 inches of water column or less. Because these types of appliances may produce vent gases under positive pressure and/or at or near their dew point, special installation considerations may be required.

Install SGV in accordance with these instructions and those of the appliance manufacturer. Consult the appliance manufacturer's instructions for the maximum length of the vent connector as well as any restriction on total vent height, proper sizing of the vent, common venting considerations and procedures for connecting the vent to the appliance. The installation must conform to applicable National, International, Regional, State and local codes. Contact the Authority having jurisdiction prior to beginning any work to obtain any required permits.

**Note:** Model SGV includes an integral seal and does not require RTV sealant. However, sealant may be necessary when connecting components directly to certain appliance flue collars.

For applications up to 570°F/288°C, approved sealants include GE RTV 106 and Dow Corning 736.

For applications up to 300°F/149°C, approved sealants include GE RTV 106 and Dow Corning 736.

**Pre-Installation Considerations:** Proper planning prior to installation is essential for maintaining proper clearances and for avoiding possible contact with concealed plumbing or electrical wiring inside walls, floors and ceilings. A continuous straight-line pitch of at least 1/4 inch (2 degrees) rise per foot on horizontal runs must be maintained in order to properly rid the system of the corrosive condensate. Be sure to plan a sufficient number of supports for the entire system to maintain the required straight-line pitch and to hold the system in place. Where the vent is enclosed within a chase, the enclosures should be built to permit future inspection of the system.

### Clearance to Combustibles and Framing Requirements

The table below shows the required MINIMUM AIRSPACE CLEARANCE TO COMBUSTIBLES. "Combustibles" include framing lumber, drywall, plywood, paneling, insulation, wiring and other building materials. This airspace clearance is required for safe operation of the vent. Failure to follow these clearances could overheat the building materials and cause a fire.

Model	Diameter	Maximum Appliance Flue Gas Temp	Minimum Clearance to Combustible Material			
			Enclosed Vent		*Unenclosed Vent	
			Vertical	Horizontal	Vertical	Horizontal
SGV	3" & 4"	480°F	4"	8"	1"	1"
SGV	3" & 4"	550°F	4"	N/A	1"	1"

\* = at least 1 side open. Combustible materials on a maximum of 3 sides

Minimum Clearance to Non-Combustibles is 0" for Flue Gas temperatures up to 550°F - all configurations

### Vertical (Floor, Ceiling and Roof) Penetrations

Where the vent passes through a floor, ceiling or roof the hole size or framing dimension must maintain minimum clearances as per above Table. Floor and Ceiling penetrations require a Firestop be installed. See Firestop section for installation instructions.

### Horizontal (Wall) Penetrations

All horizontal systems passing through a combustible wall require the use of a Wall Thimble. See Table for proper framing dimensions and refer to Wall Thimble section for installation instructions.

Non-combustible wall penetrations do not require a Wall Thimble.

Model	Diameter	Minimum Framing Dimensions
		Wall Thimble
SGV	3" & 4"	6.5" x 6.5"

## Specifications continued

**Note:** Model SGV may be intermixed in the same system as long as proper adapters are used and proper clearances are maintained for respective components.

This system may be installed in any combination of vertical and horizontal, enclosed and unenclosed configurations as long as minimum clearances are maintained per clearance Tables 1 & 2 and the total length and number of fittings does not exceed the appliance manufacturers recommendations. This system may also be installed within an existing masonry chimney.

Notes:

1. Unenclosed systems require at least one side open (combustible material on maximum of 3 sides).
2. Reduced clearances may be attained by using non-combustible enclosures.
3. Do not place insulation in any required clearance spaces surrounding the vent system unless these instructions suggest otherwise and the insulation is specified or supplied.

### Vent Routing Limitations - Maximum Equivalent Lengths

In order to insure the vent system is not overly restrictive to flow, refer to the maximum length of vent specified by the appliance manufacturer. In order to account for turns in the system (which cause additional resistance to flow) most manufacturers recommend using an "Equivalent Length" method of determining the limitations. Via such method, elbows and tees are assigned an "equivalent length" (in feet). If the sum of straight length segments and additional "equivalent lengths" (due to turns) exceeds the limit specified by the manufacturer, the routing is not permitted. See appliance manufacturer's instructions for additional information. If the appliance manufacturer's instructions do not list equivalent lengths for standard fittings, use Table 3 to determine the Equivalent Length of the vent fittings.

TECHNICAL SPECIFICATIONS	
<b>Product</b>	SGV Single Wall Special Gas Vent and Gas Vent Connector
<b>Uses</b>	Vents (Horizontal or Vertical) for Gas-Burning Applications, suitable for ANSI Category I, II, III, and IV Gas-Burning Appliances, certain Direct Vent Appliances, and approved Sealed Combustion applications
<b>Fuels</b>	Natural gas or propane fired equipment
<b>Pressure</b>	Positive up to 8" wc, negative, or neutral
<b>Standard</b>	
Diameters	3", 4"
Lengths	12", 24", 36" and Adjustable
Elbows	45° and 90°
Fittings	Complete range of Adapters, Terminations, and Accessories
<b>Flue-Gas Conduit</b>	4X3 Stainless Steel

## Typical Single Wall Installations

Vertical Installation A

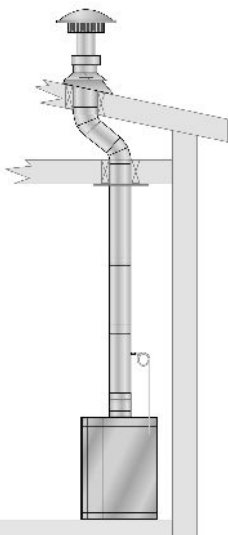

Vertical Installation B

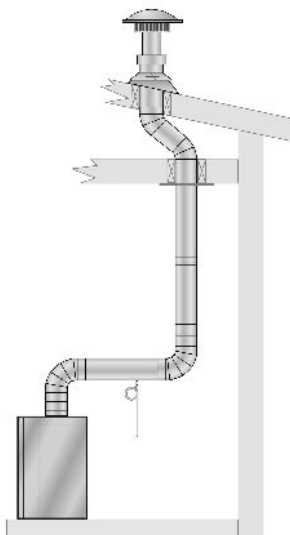

Up & Out Installation

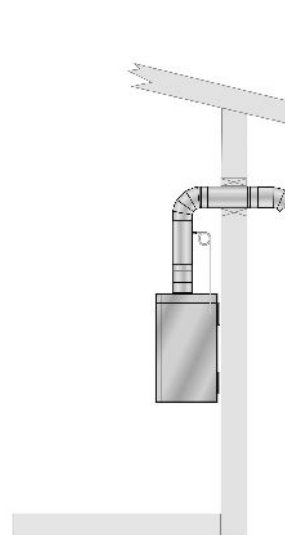

Straight Out Installation

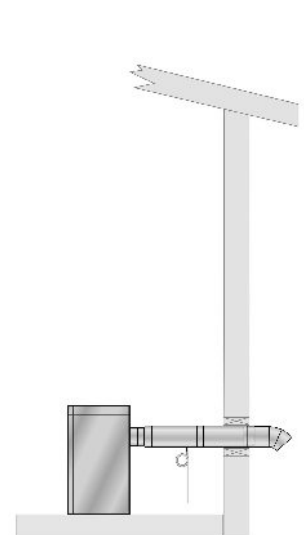

## Lengths

### Straight Lengths

- Available in 6", 12", 18", 24" and 36" lengths
- Pressure drop equal to:
  - 6" for 6" lengths
  - 12" for 12" lengths
  - 18" for 18" lengths
  - 24" for 24" lengths
  - 36" for 36" lengths

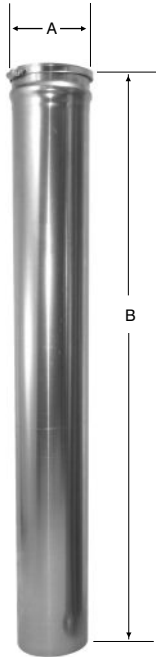

Size	Length	Dimensions		Part #
		A	B	
3"	6"	3"	4"	SGV03L6
4"	6"	4"	4"	SGV04L6
Size	Length	Dimensions		Part #
		A	B	
3"	12"	3"	10"	SGV03L12
4"	12"	4"	10"	SGV04L12
Size	Length	Dimensions		Part #
		A	B	
3"	18"	3"	16"	SGV03L18
4"	18"	4"	16"	SGV04L18
Size	Length	Dimensions		Part #
		A	B	
3"	24"	3"	22"	SGV03L24
4"	24"	4"	22"	SGV04L24
Size	Length	Dimensions		Part #
		A	B	
3"	36"	3"	34"	SGV03L36
4"	36"	4"	34"	SGV04L36

### Adjustable Lengths

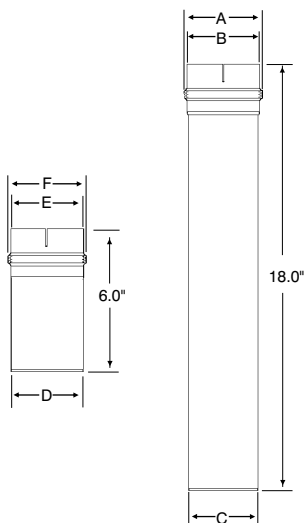

- Use to accommodate distances not possible with the standard SGV lengths. The Slip Connector serves as an adjustable section and eliminates the need to cut parts to length. The Slip Connector can have an installed length from 6 to 19 inches. It works best in conjunction with another straight length of SGV. When used with an elbow or a tee, do not insert the Slip Connector so far that air flow within the vent becomes obstructed. When planning a venting system, include one Slip Connector for every change of direction and for any spans between two fixed points. Each Slip Connector comes with two components, a slip connection and a male connector.
- Pressure drop equals 6" to 18"



Size	Length	Dimensions						Part #
		A	B	C	D	E	F	
3"	6" to 19"	3.3"	3.06"	2.92"	3.0"	3.005"	3.24"	SGV03AJ
4"	6" to 19"	4.3"	4.06"	3.92"	4.0"	4.005"	4.24"	SGV04AJ

## Lengths continued

### Vertical/Horizontal In-Line Drain Section

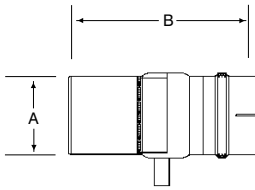

- Use to drain away condensate from the vent system. The unique design of this part allows it to be installed in a horizontal, vertical or inclined orientation. Continuous horizontal runs in excess of 30 feet require a condensate drain. High temperature silicone rubber tubing is available separately. See below.

Size	Dimensions		Part #
	A	B	
3"	3"	7.2"	SGV03DRN
4"	4"	7.2"	SGV04DRN

### Condensate Drain Tube Kit



- Contains a length of high temperature silicone rubber tubing, a clamp, and two cable ties. The silicone tubing is rated for 500°F, and is translucent to allow inspection of the P-trap. Larger diameter drains can be plumbed directly into a drain system.

Size	Dimensions		Part #
	A		
3/8"	10'		7000TUBE-10
1/2"	10'		7001TUBE

### Elbows and Tees

#### 15° Elbow

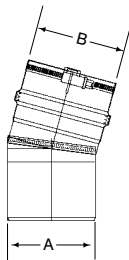

- Used to achieve offsets or changes in the direction of the vent system
- Degree of these welded seam elbows is not adjustable
- Pressure drop for each elbow is equivalent to 3 feet of vent

Size	Dimensions		Part #
	A	B	
3"	3"	3.06"	SGV03E15
4"	4"	4.06"	SGV04E15

#### 30° Elbow

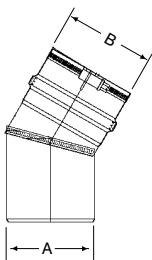

- Used to achieve offsets or changes in the direction of the vent system
- Degree of these welded seam elbows is not adjustable
- Pressure drop for each elbow is equivalent to 3 feet of vent

Size	Dimensions		Part #
	A	B	
3"	3"	3.06"	SGV03E30
4"	4"	4.06"	SGV04E30

## Elbows and Tees continued

### 45° Elbow

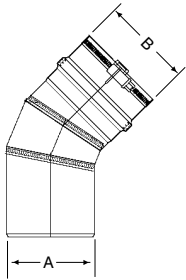

- Used to achieve offsets or changes in the direction of the vent system
- Degree of these welded seam elbows is not adjustable
- Pressure drop for each elbow is equivalent to 5 feet of vent

Size	Dimensions		Part #
	A	B	
3"	3"	3.06"	SGV03E45
4"	4"	4.06"	SGV04E45

### 90° Elbow

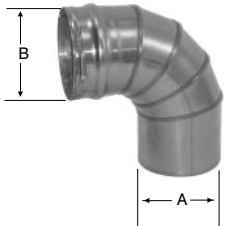

- Used to achieve offsets or changes in the direction of the vent system
- Degree of these welded seam elbows is not adjustable
- Pressure drop for each elbow is equivalent to 10 feet of vent

Size	Dimensions		Part #
	A	B	
3"	3"	3.06"	SGV03E90
4"	4"	4.06"	SGV04E90

## Support Hangars

### Support Clamp

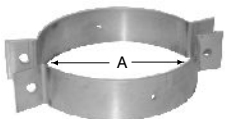

- Used with horizontal systems to provide support at the required 6-foot intervals
- Support clamps by themselves do not maintain the necessary clearances to combustible materials; be sure to consider clearances when planning the system
- Support clamps are sold in pairs with two half-shells and two 1/4-20 nuts and bolts
- Made from 18-gauge Type 304 stainless steel and should not be installed in the direct path of flue gases
- **Never drill or screw through the SGV conduit**

Size	Dimensions		Part #
	A		
3"	3"		4327SS
4"	4"		4427SS

## Support Hangars continued

### Support Leg

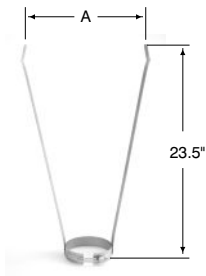

- Used on SGV systems to provide support
- 20 gauge stainless steel support legs can be used below or above the roof, and can be used in pairs for extra stabilization
- Hardware to attach the support to the structure is not provided; attach using best construction methods
- Be sure to consider clearances when planning the system
- **Never drill or screw through SGV conduit**

Size	Dimensions	Part #
	<b>A</b>	
3"	3.5"	93VSL
4"	4.5"	94VSL

### Supports

#### 1" - Clearance Horizontal / Vertical Support

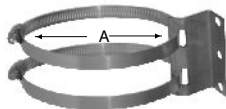

- Provides support to 3" and 4" diameter SGV systems with a 300°F maximum flue gas temperature
- When any horizontal run of SGV extends for more than 6 feet, a horizontal support must be installed. Subsequent supports are required after every additional 6 feet and every elbow and tee.
- **Never drill or screw through the SGV inner vent conduits**
- The 1" clearance may be achieved ONLY when the vent is NOT fully enclosed -- there may be combustible material on a maximum of 3 sides. This support is not recommended for use in Canada unless additional provisions are made to insure that proper clearances are maintained. Combustible material is defined by the NFPA as any material that is capable of being ignited and burned. Common paper-faced sheetrock is considered combustible.

Size	Dimensions	Part #
	<b>A</b>	
3"	3.5"	9323/1
4"	4.5"	9423/1

## Supports continued

### 2" - Clearance Horizontal Support

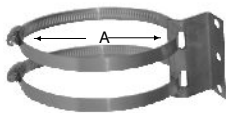

- Provides support to SGV systems with a 550°F maximum flue gas temperature
- When any horizontal run of SGV extends for more than 6 feet, a horizontal support must be installed. Subsequent supports are required after every additional 6 feet and every elbow and tee.
- **Never drill or screw through the SGV inner vent conduits**
- The 2" clearance may be achieved ONLY when the vent is NOT fully enclosed -- there may be combustible material on a maximum of 3 sides. This support is not recommended for use in Canada unless additional provisions are made to insure that proper clearances are maintained. Combustible material is defined by the NFPA as any material that is capable of being ignited and burned. Common paper-faced sheetrock is considered combustible.

Size	Dimensions	Part #
	<b>A</b>	
3"	3"	9323/2
4"	4"	9423/2

## Increases and Reducers

### Increaser

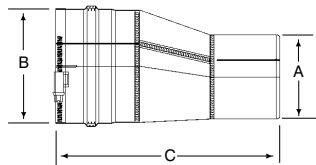

- Use to upsize a vent system
- The term "increaser" is based on an increase in vent diameter in the direction of flue gas motion. Increases are eccentric to allow for proper drainage of condensate when installed horizontally.

Size	Dimensions			Part #
	A	B	C	
3"	3"	4.06"	8"	SGV03NCR04

### Reducer

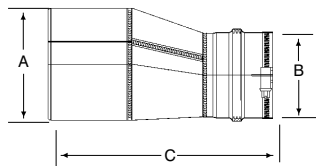

- Use to downsize a vent system. A reducer may only be used when specified or allowed by the appliance manufacturer.
- The term "reducer" is based on a reduction in vent diameter in the direction of flue gas motion. Reducers are eccentric to allow for proper drainage of condensate when installed horizontally.

Size	Dimensions			Part #
	A	B	C	
3"	4"	3.06"	8"	SGV04RDC03

## Outside the House Parts

### Screen Termination

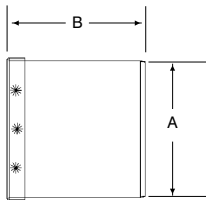

- Used as a termination on horizontal or vertical systems, as specified or allowed by the appliance manufacturer

Size	Dimensions		Part #
	A	B	
3"	3"	3"	SGV03TM
4"	4"	3"	SGV04TM

### Tee Termination with Screen

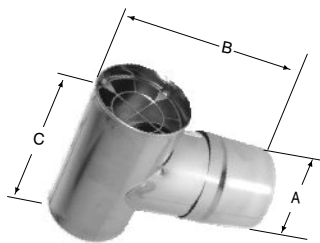

- Used as a termination on horizontal or vertical systems, as specified or allowed by the appliance manufacturer

Size	Dimensions			Part #
	A	B (Installed Length)	C	
3"	3"	3.5"	6"	SGV03TMT
4"	4"	4.5"	7"	SGV04TMT
3"	3"	13"	6"	SGV03TMTX
4"	4"	14"	7"	SGV04TMTX

### 45° Screened Termination Elbow



- Used as a termination on horizontal or vertical systems, as specified or allowed by the manufacturer

Size	Dimensions		Part #
	A	Installed Length	
3"	3"	4.9"	SGV03TM45
4"	4"	5.6"	SGV04TM45

### 90° Screened Termination Elbow



- Used as a termination on horizontal or vertical systems, as specified or allowed by the manufacturer

Size	Dimensions		Part #
	A	Installed Length	
3"	3"	4.2"	SGV03TM90
4"	4"	5.2"	SGV04TM90

### Rain Cap



- Used as a termination for vertical systems
- Category I and II appliances require a raincap or other device to prevent rainwater from entering the vent
- Prevents rain water from entering the vent
- Vent systems for positive pressure appliances may omit the rain cap if there are other provisions for draining water from the system

Size	Dimensions			Part #
	A	B	C	
3"	3"	5"	8"	SGV03RC
4"	4"	5.8"	8"	SGV04RC

### Storm Collar

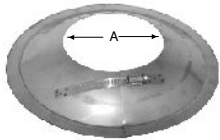

- Used on vertical systems
- May be tightened and sealed around the vent to prevent water from entering the building
- May also be used as a decorative shield to cover holes where the vent penetrates interior concrete and masonry walls
- Made from galvanized and should not be installed in the direct path of flue gases

Size	Dimensions		Part #
	A	B	
3"	3"	5.5"	9326
4"	7"	6.5"	9426

### Firestop / Wall Plate

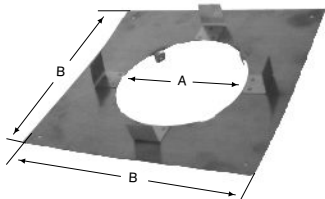

- A firestop may be required any time SGV penetrates combustible floors, walls or ceilings. Remove any insulating material from the floor, wall or ceiling cavity for at least 1 inch around the vent. Review fire codes and consult with local building code officials to determine the necessity for a firestop. This part provides added support when used at the bottom of a vertical chase. Hardware is supplied to attach the firestop to the vent. Mounting hardware is not provided.

Size	Dimensions		Part #
	A	B	
3"	3.06"	13"	SGV03FS
4"	4.06"	14"	SGV04FS

## Parts and Accessories

### Tall Cone Flashing

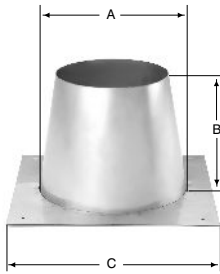

- Used with SGV systems with vertical terminations
- Can be used on flat roofs or slightly pitched roofs

Size	Dimensions			Part #
	A	B	C	
3"	7.5"	12.5"	6"	Flat to 2/12 Pitch 3RV-AF
4"	9.5"	14.5"	6"	Flat to 2/12 Pitch 4RV-AF

### Pitched Cone Flashing



- Used with SGV systems with vertical terminations
- Can be used on roofs with a 6/12 - 12/12 pitch

Size	Dimensions	Part #
3"	6/12 to 12/12 Pitch	3RV-AF12
4"	6/12 to 12/12 Pitch	4RV-AF12

### Roof Flashing

- Standard roof flashings available from local plumbing and heating suppliers may be used on SGV systems with vertical terminations
- To properly support the system separate supports may be required above or below the roofline

### Horizontal Wall Thimble

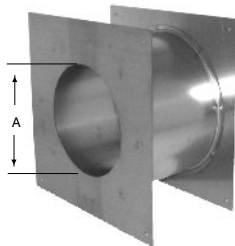

- Used to penetrate any interior or exterior combustible on non-combustible wall. This part is a thimble only and does not include any vent - be sure to order enough vent to pass through the thimble.

Size	Dimensions		Part #
	A	Face Plate Shape	
3"	3.06"	Round	SGV03TH
4"	4.06"	Round	SGV04TH
3"	3.06"	Square	SG03THS
4"	4.06"	Square	SG04THS

## Tees and Covers

### Tee Cover

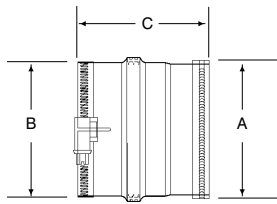

- Used to cap off the male end of a tee that is installed horizontally. The combination of a tee and a tee cover allows easy access for the periodic inspection of the vent system.

Size	Dimensions			Part #
	A	B	C	
3"	3"	3.06"	3"	SGV03TC
4"	4"	4.06"	3"	SGV04TC

### Tee Cover with Drain Fitting

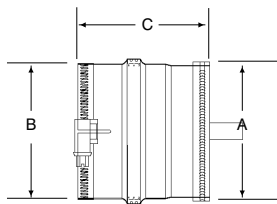

- Used at the base of a tee to drain away condensate from a vent system. This type of tee cover may also be used on the leg of a tee that is installed horizontally, to create a drain in a horizontal run.
- High temperature silicone rubber tubing is available separately from Heat-fab, see pg.3

Size	Dimensions			Part #
	A	B	C	
3"	3"	3.06"	3"	SGV03DTC
4"	4"	3.06"	3"	SGV04DTC

### Tee

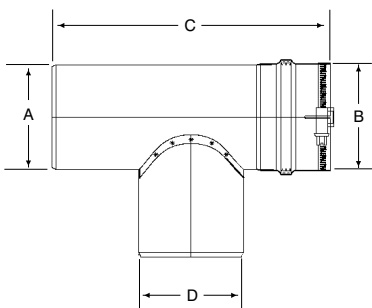

- A tee, when installed horizontally, may be fitted with a drain tee cover to create a condensate drain

Size	Dimensions				Part #
	A	B	C	D	
3"	3"	3.06"	8"	3"	SGV03TE
4"	4"	4.06"	9"	4"	SGV04TE

## Specifications

Model DGV is an advanced concentric vent system designed for close clearance installation in residential and light commercial applications. The double-wall construction of Model DGV allows the system to be fully enclosed by combustible materials at zero or 1-inch clearance depending on orientation and flue gas temperature. DGV may be used on negative, neutral, and positive pressure systems up to 8 inches w.c.

Model DGV is approved for use on ANSI Category I, II, III, and IV Gas Fired Appliances and certain Direct Vent appliances. SDG and DGV are appropriate for use on appliances that specify a ULI 738 or ULC-S636 Listed Venting System.

**As a Sealed Combustion System:** The unique concentric design of DGV also allows it to function as a pipe-in-a-pipe vent. Products of combustion are exhausted out through the inner wall while combustion air is drawn in through the annular space between the inner and outer wall. An appliance can be direct-vented with only a single penetration through the building structure. **This application must be approved by the Appliance Manufacturer.**

Install DGV in accordance with these instructions and those of the appliance manufacturer. Consult the appliance manufacturer's instructions for the maximum length of the vent connector as well as any restriction on total vent height, proper sizing of the vent, common venting considerations and procedures for connecting the vent to the appliance. The installation must conform to applicable National, International, Regional, State and local codes. Contact the Authority having jurisdiction prior to beginning any work to obtain any required permits.

**Note:** Model DGV includes an integral seal and does not require RTV sealant. However, sealant may be necessary when connecting components directly to certain appliance flue collars.

For applications up to 570°F/288°C, approved sealants include GE RTV 106 and Dow Corning 736.

For applications up to 300°F/149°C, approved sealants include GE RTV 106 and Dow Corning 736.

**Pre-Installation Considerations:** Proper planning prior to installation is essential for maintaining proper clearances and for avoiding possible contact with congealed plumbing or electrical wiring inside walls, floors and ceilings. A continuous straight-line pitch of at least 1/4 inch (2 degrees) rise per foot on horizontal runs must be maintained in order to properly rid the system of the corrosive condensate. Be sure to plan a sufficient number of supports for the entire system to maintain the required straight-line pitch and to hold the system in place. Where the vent is enclosed within a chase, the enclosures should be built to permit future inspection of the system.

### Clearance to Combustibles and Framing Requirements

The table below shows the required MINIMUM AIRSPACE CLEARANCE TO COMBUSTIBLES. "Combustibles" include framing lumber, drywall, plywood, paneling, insulation, wiring and other building materials. This airspace clearance is required for safe operation of the vent. Failure to follow these clearances could overheat the building materials and cause a fire.

Model	Diameter	Maximum Appliance Flue Gas Temp	Minimum Clearance to Combustible Material			
			Enclosed Vent		*Unenclosed Vent	
			Vertical	Horizontal	Vertical	Horizontal
DGV	3" & 4"	550°F	0" (no offsets)	N/A	0"	1"
DGV	3" & 4"	330°F	0" (w/ offsets)	0"	0"	0"
DGV	3" & 4"	400°F	1" (w/offsets)	1"	0"	0"
* = at least 1 side open. Combustible materials on a maximum of 3 sides						
Minimum Clearance to Non-Combustibles is 0" for Flue Gas temperatures up to 550°F - all configurations						

### Vertical (Floor, Ceiling and Roof) Penetrations

Where the vent passes through a floor, ceiling or roof the hole size or framing dimension must maintain minimum clearances as per above Table. Floor and Ceiling penetrations require a Firestop be installed. See Firestop section for installation instructions.

### Horizontal (Wall) Penetrations

All horizontal systems passing through a combustible wall require the use of a Wall Thimble. See Table for proper framing dimensions and refer to Wall Thimble section for installation instructions.

Non-combustible wall penetrations do not require a Wall Thimble.

Model	Diameter	Minimum Framing Dimensions
		Wall Thimble
DGV	3"	5" + (2 x Clearance from Table 1)
DGV	4"	7" + (2 x Clearance from Table 1)

## Specifications continued

**Note:** Model DGV may be intermixed in the same system as long as proper adapters are used and proper clearances are maintained for respective components.

This system may be installed in any combination of vertical and horizontal, enclosed and unenclosed configurations as long as minimum clearances are maintained per clearance Tables 1 & 2 and the total length and number of fittings does not exceed the appliance manufacturers recommendations. This system may also be installed within an existing masonry chimney.

Notes:

1. Unenclosed systems require at least one side open (combustible material on maximum of 3 sides).
2. Reduced clearances may be attained by using non-combustible enclosures.
3. Do not place insulation in any required clearance spaces surrounding the vent system unless these instructions suggest otherwise and the insulation is specified or supplied.

### Vent Routing Limitations - Maximum Equivalent Lengths

In order to insure the vent system is not overly restrictive to flow, refer to the maximum length of vent specified by the appliance manufacturer. In order to account for turns in the system (which cause additional resistance to flow) most manufacturers recommend using an "Equivalent Length" method of determining the limitations. Via such method, elbows and tees are assigned an "equivalent length" (in feet). If the sum of straight length segments and additional "equivalent lengths" (due to turns) exceeds the limit specified by the manufacturer, the routing is not permitted. See appliance manufacturer's instructions for additional information. If the appliance manufacturer's instructions do not list equivalent lengths for standard fittings, use Table 3 to determine the Equivalent Length of the vent fittings.

TECHNICAL SPECIFICATIONS	
<b>Product</b>	DGV Double Wall Special Gas Vent and Gas Vent Connector
<b>Uses</b>	Vents (Horizontal or Vertical) for Gas-Burning Applications, suitable for ANSI Category I, II, III, and IV Gas-Burning Appliances, certain Direct Vent Appliances, and approved Sealed Combustion applications
<b>Fuels</b>	Natural gas or propane fired equipment
<b>Pressure</b>	Positive up to 8" wc, negative, or neutral
<b>Standard</b>	
Diameters	3", 4"
Lengths	12", 24", 36" and Adjustable
Elbows	45° and 90°
Fittings	Complete range of Adapters, Terminations, and Accessories
<b>Flue-Gas Conduit</b>	4X3 Stainless Steel
<b>Jacket</b>	Stainless Steel

## Typical Double Wall Installations

Vertical Installation A

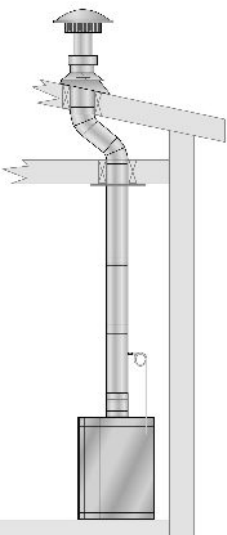

Vertical Installation B

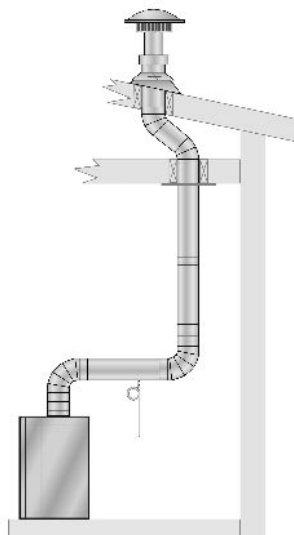

Up & Out Installation

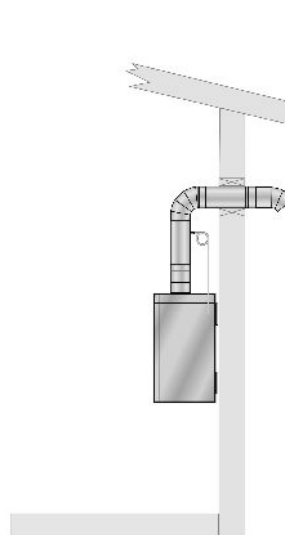

Straight Out Installation

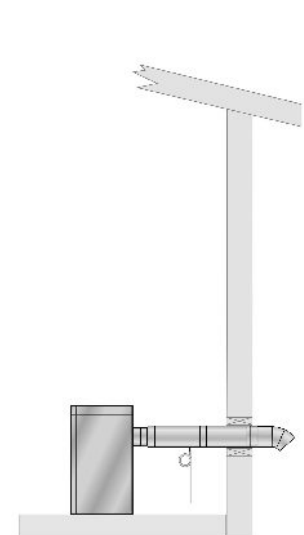

## Lengths

### Straight Lengths

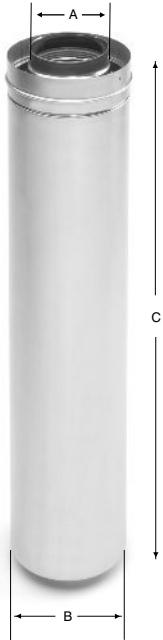

- Available in 6", 12", 24" and 36" lengths
- Install vent with a continuous pitch of 1/4" per foot, sloping upward toward the termination (unless otherwise specified by the appliance manufacturer). It is important to provide adequate support to a DGV system. Refer to installation instructions for support specifications.

#### 6" Length

Size	Length	Dimensions			Part #
		A	B	C	
3" x 5"	6"	3"	5"	3.88"	DGV03L6
4" x 7"	6"	4"	7"	3.88"	DGV04L6

#### 1' Length

Size	Length	Dimensions			Part #
		A	B	C	
3" x 5"	12"	3"	5"	9.88"	DGV03L12
4" x 7"	12"	4"	7"	9.88"	DGV04L12

#### 2' Length

Size	Length	Dimensions			Part #
		A	B	C	
3" x 5"	24"	3"	5"	21.88"	DGV03L24
4" x 7"	24"	4"	7"	21.88"	DGV04L24

#### 3' Length

Size	Length	Dimensions			Part #
		A	B	C	
3" x 5"	36"	3"	5"	35.38"	DGV03L36
4" x 7"	36"	4"	7"	35.38"	DGV04L36

### Adjustable Lengths

- Use to accommodate distances not possible with standard DGV lengths

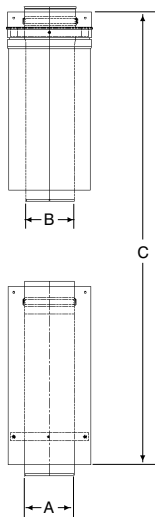

Size	Length	Dimensions			Part #
		A	B	C	
3" x 5"	12.5" to 19.5"	3"	2.92"	12.5" to 19.5"	DGV03AJ
4" x 7"	12.5" to 19.5"	4"	3.92"	12.5" to 19.5"	DGV04AJ

## Lengths continued

### Vertical/Horizontal In-Line Drain Section



- Use to drain away condensate from the vent system. The unique design of this part allows it to be installed in a horizontal, vertical or inclined orientation. Continuous horizontal runs in excess of 30 feet require a condensate drain. Drains may also be required by the manufacturer. High temperature silicone rubber tubing is available separately. See below.

Size	Dimensions					Part #
	A	B	C	D	E	
3" x 5"	3"	5"	6.7"	3.3"	0.5"	DGV03DRN
4" x 7"	4"	7"	6.7"	3.3"	0.5"	DGV04DRN

### Condensate Drain Tube Kit



- Contains a length of high temperature silicone rubber tubing, a clamp, and two cable ties. The silicone tubing is rated for 500°F, and is translucent to allow inspection of the P-trap.

Size	Dimensions	Part #
10' of 1/2" diameter tubing		7001TUBE

## Elbows Tees and Adapters

### 45° Elbow

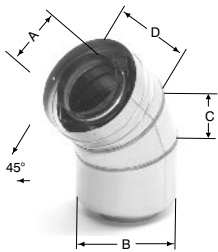

- Used to achieve offsets or changes in the direction of the vent system
- Degree of these welded seam elbows is not adjustable

Size	Dimensions					Part #
	A	B	C	D	E	
3" x 5"	3"	5"	3.1"	3.7"	11.60"	DGV03E45
4" x 7"	4"	7"	3.3"	4.3"	13.03"	DGV04E45

### 90° Elbow

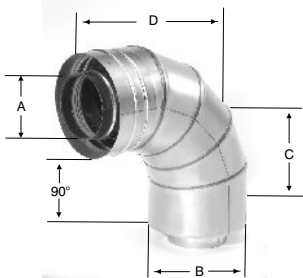

- Used to achieve offsets or changes in the direction of the vent system
- Degree of these welded seam elbows is not adjustable

Size	Dimensions					Part #
	A	B	C	D	E	
3" x 5"	3"	5"	6.1"	7"	13.1"	DGV03E90
4" x 7"	4"	7"	6.8"	7.75"	14.5"	DGV04E90

### Air Intake Tee



- Use to transition from SGV to DGV. The male end connects to appliance adapters. The outer diameter collar is vented and must not be blocked during installation or operation.

Size	Dimensions					Part #
	A	B	C	D	E	
3" x 5"	3"	5"	6.7"	4"	3"	DGV03TAD3
4" x 7"	4"	7"	8.7"	4.6"	4"	DGV04TAD4

### Single Wall Adapter



- Use to begin a Sealed Combustion system. The male end connects to SGV appliance adapters. The tap on the outer wall should be connected to the combustion air inlet on the appliance using materials specified by the appliance manufacturer.

Size	Dimensions			Part #
	A	B	C	
3"	3"	5"	1.6"	SGV03RC
4"	4"	7"	1.6"	SGV04RC

## Supports

### Outer Jacket Support Clamp

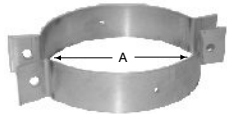

- Used with horizontal systems to provide support at the required 6-foot intervals
- May be used singly as a saddle to rest the vent in and hung from two rods or cables
- Use in pairs by clamping around the outer jacket and suspend from a single rod or cable
- Support clamps by themselves do not maintain the necessary clearances to combustible materials: be sure to consider clearances when planning the system
- Support clamps are sold in pairs with two half-shells and two 1/4-20 nuts and bolts
- **Never drill or screw through the DGV inner vent conduit**

Size	Dimensions	Part #
	A	
3"	5"	4527SS
4"	7"	4727SS

### 1" - Clearance Support Clamp

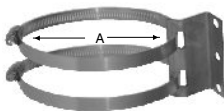

- Provides support to DGV systems that require 1 inch clearance to combustible materials
- When any horizontal run of DGV extends for more than 6 feet, a horizontal support must be installed. Subsequent supports are required after every additional 6 feet and every elbow and tee. Be sure to consider clearances and proper pitch when planning the system.
- **Never drill or screw through the DGV inner vent conduits**

Size	Dimensions	Part #
	A	
3"	5.5"	SC03SUP1
4"	7.5"	SC04SUP1

## Supports continued

### 0" - Clearance Horizontal/Vertical Support Clamp

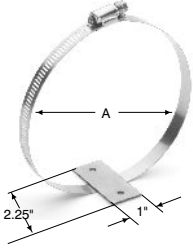

- For use on horizontal or vertical systems to provide support at zero clearance to combustible materials
- When any horizontal run extends for more than 6 feet, a horizontal support must be installed. Subsequent supports are required after every additional 6 feet and every elbow and tee. Attach the bracket to the structure using appropriate hardware (not provided). This part consists of a hose clamp and an 18-gauge stainless steel mounting bracket. Be sure to consider proper pitch when planning the system.
- **Never drill or screw through the DGV inner vent conduits**

Size	Dimensions	Part #
	<b>A</b>	
3"	5.5"	SC03SUP
4"	7.5"	SC04SUP

### Vertical Support Leg

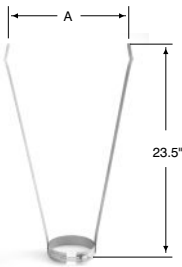

- Used on vertical systems to provide support
- 20 gauge stainless steel support legs can be used below or above the roof, and can be used in pairs for extra stabilization
- Hardware to attach the support to the structure is not provided; attach using best construction methods
- Be sure to consider clearances when planning the system
- **Never drill or screw through DGV inner vent conduit**

Size	Dimensions	Part #
	<b>A</b>	
3"	5.2"	SC03VSL
4"	7.2"	SC04VSL

## Parts & Accessories

### Firestop / Support / Wall Plate

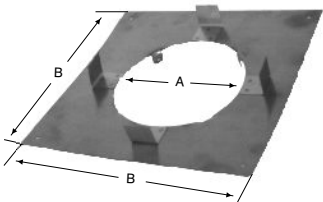

- A firestop may be required anytime DGV penetrates combustible floors, walls or ceilings. Remove any insulating material from the floor, wall or ceiling cavity for at least 1 inch around the vent. Review fire codes and consult with local building code officials to determine the necessity for a firestop. This part provides added support when used at the bottom of a vertical chase. Hardware is supplied to attach the firestop to the vent. Mounting hardware is not provided.

Size	Dimensions		Part #
	A	B	
3"	5"	8"	SC03FS
3"	5"	12"	SC04FSA
4"	7"	10"	SC04FS
4"	7"	12"	SC04FSA

### Tall Cone Flashing / Support

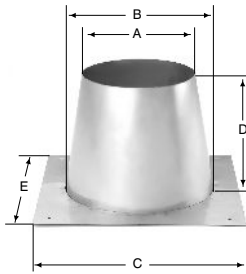

- Used as a vertical roof penetration and support for flat roof installations
- Must be installed with a 5 inch diameter Storm Collar (ordered separately)
- Hardware is not included with the Tall Cone Flashing; attach to structure using best construction methods. The Tall Cone Flashing may be used with a roof curb if necessary.

Size	Dimensions					Part #
	A	B	C	D	E	
3"	5.5"	7.5"	12.5"	6"	Flat to 2/12 Pitch	SC03TCF
3"	5.5"	7.5"	12.5"	6"	2/12 to 6/12 Pitch	SC03TCFA
3"	5.5"	7.5"	12.5"	6"	6/12 to 12/12 Pitch	SC03TCFB
4"	7.5"	9.5"	14.5"	6"	Flat to 2/12 Pitch	SC04TCF
4"	7.5"	9.5"	14.5"	6"	2/12 to 6/12 Pitch	SC04TCFA
4"	7.5"	9.5"	14.5"	6"	6/12 to 12/12 Pitch	SC04TCFB

### Storm Collar

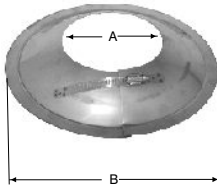

- Used with the Tall Cone Flashing (sold separately) or other roof flashings to provide support to vertical installations
- May be tightened and sealed around the vent to prevent water from entering the building
- May also be used as a decorative shield to cover holes where the vent penetrates interior concrete and masonry walls
- Made from Type 304 Stainless Steel and should not be installed in the direct path of flue gases

Size	Dimensions		Part #
	A	B	
3"	5"	12"	4526SS
4"	7"	14"	4726SS

## Outside the House Parts

### Vertical Termination Adapter

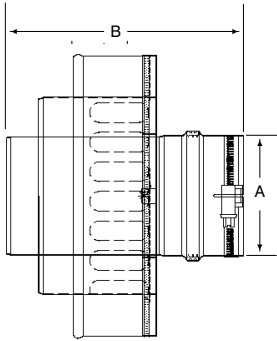

- Use to complete the DGV system on vertical installations
- Standard SGV terminations connect directly to the adapter. Screened openings release excess heat from the system and must not be blocked. On Sealed Combustion systems the screened openings supply combustion air to the appliance.

Size	Dimensions		Part #
	A	B	
3"	3"	5.88"	DGV03VT
4"	4"	5.88"	DGV04VT

### Horizontal Termination Adapter

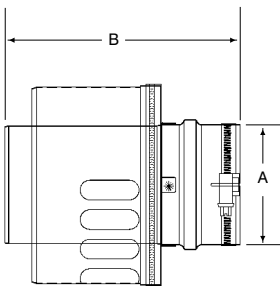

- Use to complete the DGV system after penetrating an exterior wall
- Standard SGV terminations connect directly to the adapter. Screened openings release excess heat from the system and must not be blocked. On Sealed Combustion systems the screened openings supply combustion air to the appliance.

Size	Dimensions		Part #
	A	B	
3"	3"	6"	DGV03HT
4"	4"	6"	DGV04HT

### NOTE

**Use above the Termination Adapters to convert DGV for use with SGV Terminations**

### Rain Cap



- Used as a termination for vertical systems
- Category I and II appliances require a raincap or other device to prevent rainwater from entering the vent
- Prevents rain water from entering the vent
- Vent systems for positive pressure appliances may omit the rain cap if there are other provisions for draining water from the system

Size	Dimensions			Part #
	A	B	C	
3"	3"	5"	8"	SGV03RC
4"	4"	5.8"	8"	SGV04RC

### Screen Termination

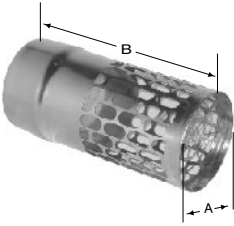

- Used as a termination on horizontal or vertical systems, as specified or allowed by the appliance manufacturer

Size	Dimensions		Part #
	A	B	
3"	3"	6.25"	SGV03TM
4"	4"	7.25"	SGV04TM

### Tee Termination with Screen

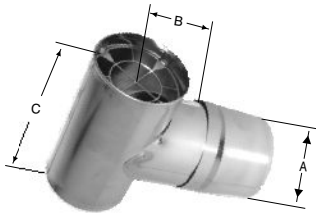

- Used as a termination on horizontal or vertical systems, as specified or allowed by the appliance manufacturer

Size	Dimensions			Part #
	A	B	C	
3"	3"	3.5"	6"	SGV03TMT
4"	4"	4"	7"	SGV04TMT
3"	3"	13"	6"	SGV03TMTX
4"	4"	14"	7"	SGV04TMTX

### 45° Screened Termination Elbow

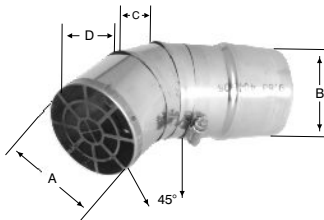

- Used as a termination on horizontal or vertical systems, as specified or allowed by the appliance manufacturer

Size	Dimensions				Part #
	A	B	C	D	
3"	3"	3.5"	3.8"	4.9"	SGV03TM45
4"	3"	4"	4.2"	5.6"	SGV04TM45

### 90° Screened Termination Elbow



- Used as a termination on horizontal or vertical systems, as specified or allowed by the appliance manufacturer
- Directs the exhaust down

Size	Dimensions	Part #
	A	
3"	4"	SGV03TM90
4"	4"	SGV04TM90

# All HVAC Products Are Not Created Equal.



Type "B" Gas Vent



Chimney Liners

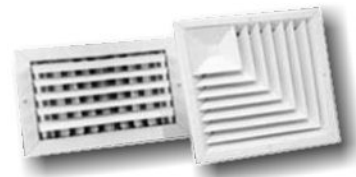

Registers, Grilles, Diffusers and  
T-Bar Lay-in Diffusers



Insulated Chimney Systems



Special Gas Vent



Direct Vent Pipe

## Complete Product Lines to Meet Your Market Needs!

### Hearth Products

**Chimney:**

Ultra-Temp  
Ultra-Temp Large  
Galva-Temp  
Galva-Temp Large

**Fireplaces:**

MAX! HE

**Venting:**

Direct-Temp / Gas  
Direct-Temp / Pellet  
Direct-Temp / Multi-Fuel  
Double Wall Stove Pipe  
Saf-T Pipe  
VP Pellet Pipe  
Flexi-Liner  
Versa-Liner  
Saf-T Liner

### HVAC Products

**AirMate:**

Registers  
Grilles  
Diffusers

**Chimney:**

Ultra-Temp  
Ultra-Temp Large  
Galva-Temp  
Galva-Temp Large

**Venting:**

Direct-Temp / Gas  
RV & QC Type B Gas Vent  
DFS Type L Vent  
Flexi-Liner  
Versa-Liner  
Saf-T Vent Special Gas Vent



*Reduce, Reuse, Recycle*  
Our literature is printed on  
recyclable paper



5030 Corporate Exchange Blvd.  
Grand Rapids, MI 49512  
Toll Free: 1.800.433.6341

[www.heatfab.com](http://www.heatfab.com)

P.O. Box 526, Depot 1  
Hamilton, ON L8L 7X6  
Toll Free: 1.888.SELKIRK (735.5475)